



CT40-55-70 BT Quick guide



This guide is intended for quick consultation only and does not replace the user and maintenance manual. Before using the machine, read the user and maintenance manual contained in the machine's packaging thoroughly and strictly follow all the instructions.

PREPARATION & OPERATION

<p>1</p> <p></p>	<p>2</p> <p></p>	<p>3</p> <p></p>
<p>4</p> <p></p>	<p>5</p> <p></p>	<p>6</p> <p></p>
<p>7</p> <p></p>	<p>8</p> <p></p>	<p>9</p> <p></p>

DAILY MAINTENANCE

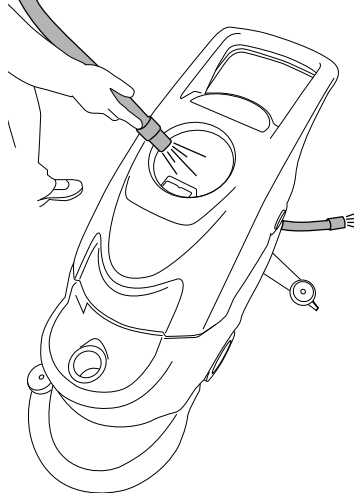
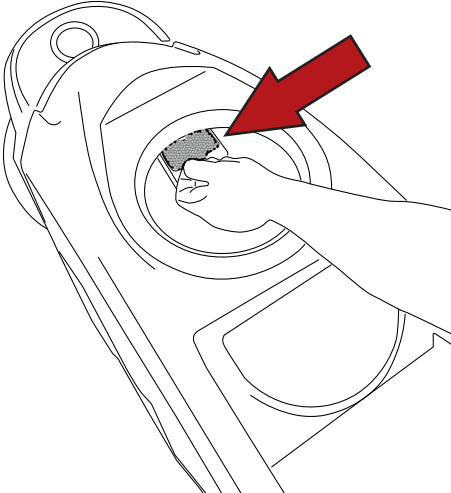
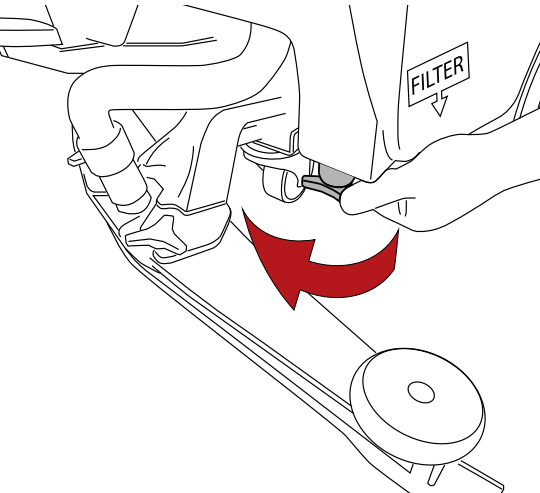
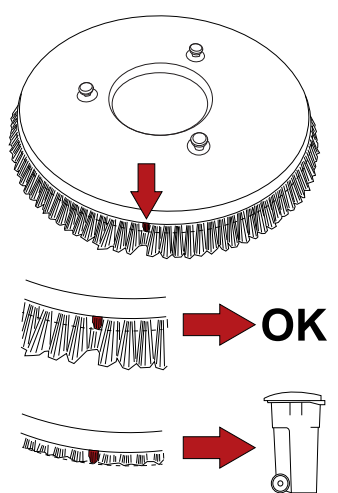
			
<p>Clean the dirty water tank.</p>	<p>Check the suction filter is undamaged and clean.</p>	<p>Check that the detergent outlet filter is clean.</p>	<p>Check that the brush is clean. Replace if necessary.</p>

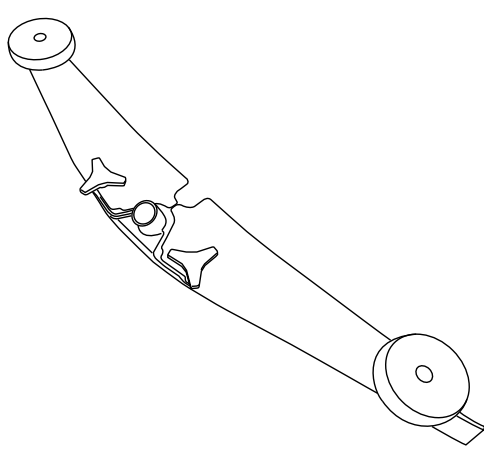
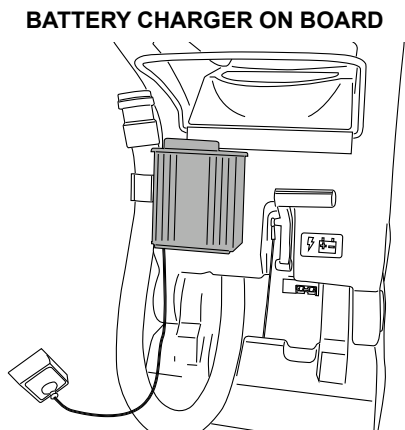
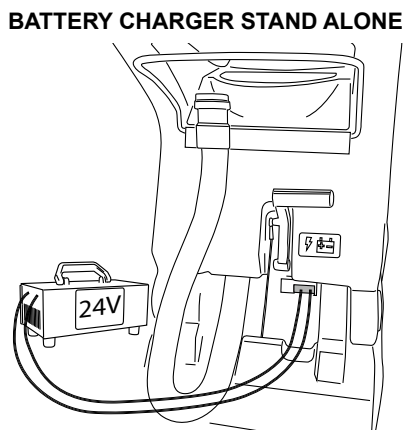
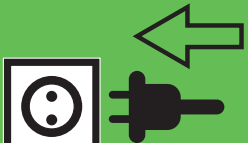
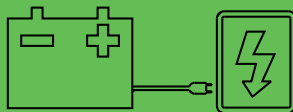
	<p>BATTERY CHARGER ON BOARD</p> 	<p>BATTERY CHARGER STAND ALONE</p> 
<p>Check that the squeegee is clean and the blades are not worn.</p>		

REPLACING THE SQUEEGEE BLADES

Open the clip (Ref. 1).
 Remove the two blade retainers (Ref. 2) by pushing them outwards then extracting them.
 Remove the blade.
 Reuse the same blade by reversing the edge in contact with the floor until all four edges are worn out, or replace with a new blade, fitting it onto the screws on the body of the squeegee.
 Reposition the two blade pressing devices by centering the wider part of the slots on the squeegee body fastening pins, then push the blade pressing devices inwards.
 Close the hook again.
 Replace the squeegee on its support, following the instructions described previously.

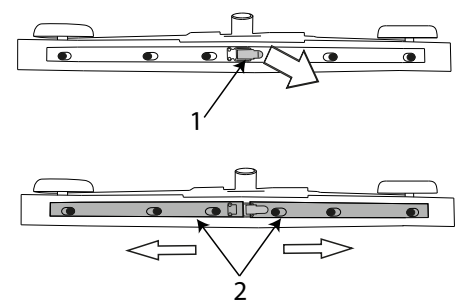

ATTACHING/REMOVING THE BRUSHES

Attaching the brush: rest the brush on the floor in front of the machine and centre it with the guard. Lower the head and operate the brush/drive lever repeatedly until the brush automatically engages on the flange hub. If the operation is not successful, repeat by pressing on the lever again and repeating the centring.

Removing the brush: raise the machine head by pushing the head lift pedal down and then to the right and operate the brush/drive lever repeatedly. After operating the lever a few times, the brush is released and falls to the ground.